

		Revision	
Rev.	Description	Date	Approved
A	NEW TOOLING	01-18-07	DP

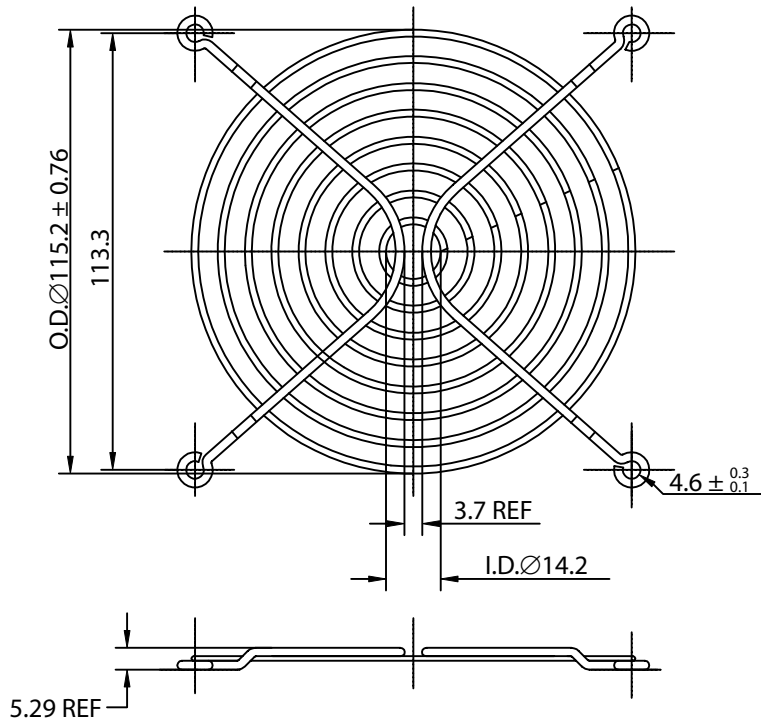

NOTES:

1. MATERIAL: C1008 BRIGHT BASIC WIRE
2. FINISH: BRIGHT NICKEL CHROME PLATING
3. 0.35 ± 0.05 DEPTH OF SERRATIONS ON WIRE
4. RING:  $\varnothing 1.8 \pm 0.1\text{mm}$   
RIB:  $\varnothing 2.3 \pm 0.1\text{mm}$
5. GENERAL TOLERANCE UNLESS NOTED IS  $\pm 0.5\text{mm}$
6. RoHS COMPLIANT

Dim range (mm)	Tolerance +/- (mm)	Qualtek Electronics Corp. FAN-S DIVISION		
		Part Number:	08135	RoHS Compliant
0-1	0.15	Description: WIRE FORM FAN GUARD (120mm)		
1-6	0.20		UNIT: mm	REV: A
6-18	0.30			
18-50	0.50			
50-120	0.70	Drawn / Date	Checked / Date	Approved / Date
120-250	0.90	B. Grubb 01-18-07	01-18-07	JJH / 01-18-07
250-500	1.20			